



Daikin Altherma mid  
temperature split  
Technical Data  
ELBH-E6V / ELBH-E9W /  
ELBX-E6V / ELBX-E9W





# TABLE OF CONTENTS

## ELBH-E6V / ELBH-E9W / ELBX-E6V / ELBX-E9W

---

1	<b>Features</b>	4
	ELBX-E6V, ELBX-E9W, ELBH-E6V, ELBH-E9W	4
2	<b>Specifications</b>	5
3	<b>Electrical data</b>	13
4	<b>Combination table</b>	15
5	<b>Dimensional drawings</b>	16
6	<b>Centre of gravity</b>	17
7	<b>Piping diagrams</b>	18
8	<b>Wiring diagrams</b>	19
	Notes & Legend	19
	Control Circuit	20
	Power Supply, Back-up Heater	23
9	<b>External connection diagrams</b>	24
10	<b>Installation</b>	25
	Installation Method	25
11	<b>Operation range</b>	26
12	<b>Hydraulic performance</b>	27
	Static Pressure Drop Unit	27

# 1 Features

1 - 1 ELBX-E6V, ELBX-E9W, ELBH-E6V, ELBH-E9W

Wall mounted reversible air to water heat pump ideal for low energy houses

1

- › Quick configuration in 9 steps in a high resolution colour interface wizard
- › Compact dimensions allows for small installation space, as almost no side clearances are required.
- › Combine with a stainless steel tank or ECH2O thermal store.
- › Inclusion of all hydraulic components means no third party components are required
- › The unit's sleek design blends in with other household appliances.



Onecta app

# 2 Specifications

## 2 - 1 Specifications

Technical specifications				ELBH12E6V	
Heater capacity	Step1		kW	2	
	Step2		kW	2 or 4	
Casing	Colour			White + Black	
	Material			Resin, sheet metal	
Dimensions	Unit	Height	mm	840	
		Width	mm	440	
		Depth	mm	390	
	Packed unit	Height	mm	450	
		Width	mm	650	
		Depth	mm	1,016	
Weight	Unit		kg	48.5	
	Packed unit		kg	60	
Packing	Material			Carton / EPS / PE (Straps) / Wood (pallet)	
	Weight		kg	12	
PED	Category			Category II	
	Most critical part	Name	Ps*V	Bar*l	
					Plate heat exchanger
Refrigerant side heat exchanger	Type			Plate heat exchanger	
	Quantity			1	
	Plates	Quantity		66	
Pump	Type			Grundfos UPM4L K 15-75 130 9 DKI	
	Nr of speeds			PWM	
	Power input		W	70	
Water side Heat exchanger	Type			Plate heat exchanger	
	Model			ACH43-66AH-F	
	Quantity			1	
	Plates	Quantity		66	
	Water volume		l	1.58	
	Water flow rate	Min.	l/min	20.0 (1)	
Expansion vessel	Volume		l	10	
	Max. water pressure		bar	3	
	Pre pressure		bar	1	
Water filter	Diameter perforations		mm	0.8	
	Material			Stainless steel / Plastic	
General	Supplier/ Manufacturer details	Name or trademark		Daikin Europe N.V.	
		Name and address		Daikin Europe N.V. - Zandvoordestraat 300, 8400 Oostende, Belgium	
Water circuit	Piping connections diameter		inch	G 1" (female)	
	Piping material			Cu	
	Internal piping diameter		inch	1"	
	Piping		inch	1"	
	Safety valve		bar	3	
	Manometer			Digital	
	Drain valve / fill valve			Yes	
	Shut off valve			Yes	
	Air purge valve			Yes	
	Total water volume		l	3.6	
	Minimum water volume in the system for cooling		l	20 (2)	
	Minimum water volume in the system for heating		l	20 (2)	
	Refrigerant circuit	Gas side diameter		mm	15.9
Liquid side diameter			mm	6.35	
Sound power level	Nom.		dBA	44.0 (3)	
Sound pressure level	Nom.		dBA	30.0 (4)	
Operation range	Heating	Ambient	Min.	°C	-25 (5)
			Max.	°C	25 (5)
		Water side	Min.	°C	15 (5)
			Max.	°C	65 (5)
	Indoor installation	Ambient	Min.	°CDB	5
			Max.	°CDB	35
	Cooling	Ambient	Min.	°CDB	10 (5)
			Max.	°CDB	43 (5)
		Water side	Min.	°C	5 (5)
			Max.	°C	22 (5)
	Domestic hot water	Ambient	Min.	°CDB	-25 (5)
			Max.	°CDB	35 (5)
		Water side	Min.	°C	25 (5)
			Max.	°C	62 (5)
Safety devices	Item	01		Thermal cut out	

## 2 Specifications

### 2 - 1 Specifications

2

Electrical specifications				ELBH12E6V	
Power supply	Name			See note 7	
	Voltage range	Min.	%	-10	
Max.		%		10	
IP class	IP			IP X0B	
Electric heater	Power supply	Name		6V3	
		Phase		1~ / 3~	
		Frequency	Hz	50	
		Voltage	V	230	
	Current	Maximum running current	A	26.0	
		Zmax List	Ω	0.22	
Minimum Ssc value			Equipment complying with EN/IEC 61000-3-12		
Wiring connections	Recommended fuses	A		20.000 (6)	
	Communication cable	Quantity		3+GRD	
		Remark			1.5 mm <sup>2</sup>
	Electric meter	Quantity			2
		Remark			Minimum 0.75 mm <sup>2</sup> (5VDC pulse detection)
	Preferential kWh rate power supply	Quantity			Power: 2
		Remark			Power 6.3A (Select diameter and type according to national and local regulations)
	Domestic hot water pump	Quantity			2
		Remark			Minimum 0.75 mm <sup>2</sup> (2A inrush, 1A continuous)
	For power supply back-up heater	Quantity			Prewired
		Remark			Select diameter & type according to national & local regulations
	For connection with R6T	Quantity			2
		Remark			Minimum 0.75 mm <sup>2</sup>
	For connection with A3P	Quantity			Depends on thermostat type, cf. installation manual
Remark				Voltage: 230V / Max. current: 100mA / Min. 0.75mm <sup>2</sup> / See note 8	
For connection with M2S	Quantity			2	
	Remark			Voltage: 230V / Max. current: 100mA / Min. 0.75mm <sup>2</sup> / See note 8	
For connection with optional FWXV* (demand input and output)	Quantity			4	
	Remark			100 mA, minimum 0.75 mm <sup>2</sup>	

(1) Operation area is extended to lower flow rates depending on operation mode - refer to ESP curve. |

(2) Excluding the water volume in the unit. This volume will guarantee sufficient defrost energy for all applications, however, this volume can be multiplied by 0,66 if the heating setpoint is  $\geq 45^{\circ}\text{C}$  (eg. Fan coils) |

(3) Measured with a pressure drop of 10 kPa in the heating system at an operating condition of leaving water  $47-55^{\circ}\text{C}$  in a room with an ambient of  $20^{\circ}\text{C}$ . DB/WB  $7^{\circ}\text{C}/6^{\circ}$ . |

(4) Sound values are measured in a semi-anechoic room. Sound pressure level is a relative value, depending on the distance and acoustic environment. For more details, please refer to the sound level drawings. Sound power level is an absolute value that is so |

(5) For more details, see operation range drawing |

(6) 4 pole 20 A curve 400V tripping class C (refer to wiring diagram) |

(7) Above mentioned power supply of the hydrobox is for the backup heater only. The switch box and the pump of the hydrobox are supplied via the outdoor unit. The optional domestic hot water tank has a separate power supply. |

Select diameter and type according to national and local regulations

Technical specifications				ELBH12E9W
Heater capacity	Step1	kW		3
	Step2	kW		max. 6 kW
Casing	Colour			White + Black
	Material			Resin, sheet metal
Dimensions	Unit	Height	mm	840
		Width	mm	440
		Depth	mm	390
	Packed unit	Height	mm	450
		Width	mm	650
		Depth	mm	1,016
Weight	Unit	kg		48.5
	Packed unit	kg		60
Packing	Material			Carton / EPS / PE (Straps) / Wood (pallet)
	Weight	kg		12
PED	Category			Category II
	Most critical part	Name		Plate heat exchanger
		Ps*V	Bar*l	
Refrigerant side heat exchanger	Type			Plate heat exchanger
	Quantity			1
	Plates	Quantity		66

# 2 Specifications

## 2 - 1 Specifications

2

Technical specifications					ELBH12E9W	
Pump	Type	Grundfos UPM4L K 15-75 130 9 DKI				
	Nr of speeds	PWM				
	Power input	W	70			
Water side Heat exchanger	Type	Plate heat exchanger				
	Model	ACH43-66AH-F				
	Quantity	1				
	Plates	Quantity	66			
	Water volume	1.58				
	Water flow rate	Min.	l/min	20.0 (1)		
Expansion vessel	Volume	l	10			
	Max. water pressure	bar	3			
	Pre pressure	bar	1			
Water filter	Diameter perforations	mm	0.8			
	Material	Stainless steel / Plastic				
General	Supplier/ Manufacturer details	Name or trademark Name and address	Daikin Europe N.V. Daikin Europe N.V. - Zandvoordestraat 300, 8400 Oostende, Belgium			
	Water circuit	Piping connections diameter	inch	G 1" (female)		
	Piping material	Cu				
	Internal piping diameter	inch	1"			
	Piping	inch	1"			
	Safety valve	bar	3			
	Manometer	Digital				
	Drain valve / fill valve	Yes				
	Shut off valve	Yes				
	Air purge valve	Yes				
	Total water volume	l	3.6			
	Minimum water volume in the system for cooling	l	20 (2)			
	Minimum water volume in the system for heating	l	20 (2)			
Refrigerant circuit	Gas side diameter	mm	15.9			
	Liquid side diameter	mm	6.35			
Sound power level	Nom.	dB(A)	44.0 (3)			
Sound pressure level	Nom.	dB(A)	30.0 (4)			
Operation range	Heating	Ambient	Min.	°C	-25 (5)	
			Max.	°C	25 (5)	
		Water side	Min.	°C	15 (5)	
			Max.	°C	65 (5)	
	Indoor installation	Ambient	Min.	°CDB	5	
			Max.	°CDB	35	
	Cooling	Ambient	Min.	°CDB	10 (5)	
			Max.	°CDB	43 (5)	
		Water side	Min.	°C	5 (5)	
			Max.	°C	22 (5)	
	Domestic hot water	Ambient	Min.	°CDB	-25 (5)	
			Max.	°CDB	35 (5)	
		Water side	Min.	°C	25 (5)	
			Max.	°C	62 (5)	
Safety devices	Item	01	Thermal cut out			

Electrical specifications					ELBH12E9W	
Power supply	Name	See note 7				
	Voltage range	Min.	%	-10		
		Max.	%	10		
IP class	IP	IP X0B				
Electric heater	Power supply	Name	9W			
		Phase	3~			
		Frequency	Hz	50		
		Voltage	V	400		
	Current	Maximum running current	A	13.0		
	Recommended fuses	A	20.000 (6)			

# 2 Specifications

## 2 - 1 Specifications

2

Electrical specifications			ELBH12E9W
Wiring connections	Communication cable	Quantity	3+GRD
		Remark	1.5 mm <sup>2</sup>
	Electric meter	Quantity	2
		Remark	Minimum 0.75 mm <sup>2</sup> (SVDC pulse detection)
	Preferential kWh rate	Quantity	Power: 2
		Remark	Power 6.3A (Select diameter and type according to national and local regulations)
	Domestic hot water pump	Quantity	2
		Remark	Minimum 0.75 mm <sup>2</sup> (2A inrush, 1A continuous)
	For power supply back-up heater	Quantity	Prewired
		Remark	Select diameter & type according to national & local regulations
	For connection with R6T	Quantity	2
		Remark	Minimum 0.75 mm <sup>2</sup>
	For connection with A3P	Quantity	Depends on thermostat type, cf. installation manual
		Remark	Voltage: 230V / Max. current: 100mA / Min. 0.75mm <sup>2</sup> / See note 8
	For connection with M2S	Quantity	2
Remark		Voltage: 230V / Max. current: 100mA / Min. 0.75mm <sup>2</sup> / See note 8	
For connection with optional FWXV* (demand input and output)	Quantity	4	
	Remark	100 mA, minimum 0.75 mm <sup>2</sup>	

(1) Operation area is extended to lower flow rates depending on operation mode - refer to ESP curve. |

(2) Excluding the water volume in the unit. This volume will guarantee sufficient defrost energy for all applications, however, this volume can be multiplied by 0,66 if the heating setpoint is  $\geq 45^{\circ}\text{C}$  (eg. Fan coils) |

(3) Measured with a pressure drop of 10 kPa in the heating system at an operating condition of leaving water  $47\text{-}55^{\circ}\text{C}$  in a room with an ambient of  $20^{\circ}\text{C}$ . DB/WB  $7^{\circ}\text{C}/6^{\circ}$ . |

(4) Sound values are measured in a semi-anechoic room. Sound pressure level is a relative value, depending on the distance and acoustic environment. For more details, please refer to the sound level drawings. Sound power level is an absolute value that a so |

(5) For more details, see operation range drawing |

(6) 4 pole 20 A curve 400V tripping class C (refer to wiring diagram) |

(7) Above mentioned power supply of the hydrobox is for the backup heater only. The switch box and the pump of the hydrobox are supplied via the outdoor unit. The optional domestic hot water tank has a separate power supply. |

Select diameter and type according to national and local regulations

Technical specifications			ELBX12E6V	
Heater capacity	Step 1	kW	2	
	Step 2	kW	2 or 4	
Casing	Colour		White + Black	
	Material		Resin, sheet metal	
Dimensions	Unit	Height	mm	840
		Width	mm	440
		Depth	mm	390
	Packed unit	Height	mm	450
		Width	mm	650
		Depth	mm	1,016
Weight	Unit	kg	48.5	
	Packed unit	kg	60	
Packing	Material		Carton / EPS / PE (Straps) / Wood (pallet)	
	Weight	kg	12	
PED	Category		Category II	
	Most critical part	Name		Plate heat exchanger
		P <sub>s</sub> *V	Bar*l	60
Refrigerant side heat exchanger	Type		Plate heat exchanger	
	Quantity		1	
	Plates	Quantity	66	
Pump	Type		Grundfos UPM4L K 15-75 130 9 DK1	
	Nr of speeds		PWM	
	Power input	W	70	
Water side Heat exchanger	Type		Plate heat exchanger	
	Model		ACH43-66AH-F	
	Quantity		1	
	Plates	Quantity	66	
	Water volume	l	1.58	
	Water flow rate	Min. l/min	20.0 (1)	
	Expansion vessel	Volume	l	10
	Max. water pressure	bar	3	
	Pre pressure	bar	1	

# 2 Specifications

## 2 - 1 Specifications

Technical specifications				ELBX12E6V		
Water filter	Diameter perforations		mm	0.8		
	Material			Stainless steel / Plastic		
General	Supplier/ Name or trademark			Daikin Europe N.V.		
	Manufacturer Name and address details			Daikin Europe N.V. - Zandvoordestraat 300, 8400 Oostende, Belgium		
Water circuit	Piping connections diameter		inch	G 1" (female)		
	Piping material			Cu		
	Internal piping diameter		inch	1"		
	Piping		inch	1"		
	Safety valve		bar	3		
	Manometer			Digital		
	Drain valve / fill valve			Yes		
	Shut off valve			Yes		
	Air purge valve			Yes		
	Total water volume		l	3.6		
	Minimum water volume in the system for cooling		l	20 (2)		
Minimum water volume in the system for heating		l	20 (2)			
Refrigerant circuit	Gas side diameter		mm	15.9		
	Liquid side diameter		mm	6.35		
Sound power level	Nom.		dB(A)	44.0 (3)		
Sound pressure level	Nom.		dB(A)	30.0 (4)		
Operation range	Heating	Ambient	Min.	°C	-25 (5)	
			Max.	°C	25 (5)	
		Water side	Min.	°C	15 (5)	
			Max.	°C	65 (5)	
	Indoor installation	Ambient	Min.	°CDB	5	
			Max.	°CDB	35	
		Cooling	Ambient	Min.	°CDB	10 (5)
				Max.	°CDB	43 (5)
	Domestic hot water	Water side	Min.	°C	5 (5)	
			Max.	°C	22 (5)	
		Ambient	Min.	°CDB	-25 (5)	
			Max.	°CDB	35 (5)	
	Water side	Min.	°C	25 (5)		
		Max.	°C	62 (5)		
Safety devices	Item	01		Thermal cut out		
Electrical specifications				ELBX12E6V		
Power supply	Name			See note 7		
	Voltage range	Min.	%	-10		
		Max.	%	10		
IP class	IP			IP X0B		
Electric heater	Power supply	Name		6V3		
		Phase		1~ / 3~		
		Frequency		Hz	50	
		Voltage		V	230	
	Current	Maximum running current		A	26.0	
		Zmax	List	Ω	0.22	
		Minimum Ssc value			Equipment complying with EN/IEC 61000-3-12	
	Recommended fuses		A		20.000 (6)	

## 2 Specifications

### 2 - 1 Specifications

2

Electrical specifications			ELBX12E6V
Wiring connections	Communication cable	Quantity	3+GRD
		Remark	1.5 mm <sup>2</sup>
	Electric meter	Quantity	2
		Remark	Minimum 0.75 mm <sup>2</sup> (SVDC pulse detection)
	Preferential kWh rate	Quantity	Power: 2
		Remark	Power 6.3A (Select diameter and type according to national and local regulations)
	Domestic hot water pump	Quantity	2
		Remark	Minimum 0.75 mm <sup>2</sup> (2A inrush, 1A continuous)
	For power supply back-up heater	Quantity	Prewired
		Remark	Select diameter & type according to national & local regulations
	For connection with R6T	Quantity	2
		Remark	Minimum 0.75 mm <sup>2</sup>
	For connection with A3P	Quantity	Depends on thermostat type, cf. installation manual
		Remark	Voltage: 230V / Max. current: 100mA / Min. 0.75mm <sup>2</sup> / See note 8
For connection with M2S	Quantity	2	
	Remark	Voltage: 230V / Max. current: 100mA / Min. 0.75mm <sup>2</sup> / See note 8	
For connection with optional FWXV* (demand input and output)	Quantity	4	
	Remark	100 mA, minimum 0.75 mm <sup>2</sup>	

(1) Operation area is extended to lower flow rates depending on operation mode - refer to ESP curve. |

(2) Excluding the water volume in the unit. This volume will guarantee sufficient defrost energy for all applications, however, this volume can be multiplied by 0,66 if the heating setpoint is  $\geq 45^{\circ}\text{C}$  (eg. Fan coils) |

(3) Measured with a pressure drop of 10 kPa in the heating system at an operating condition of leaving water  $47\text{-}55^{\circ}\text{C}$  in a room with an ambient of  $20^{\circ}\text{C}$ . DB/WB  $7^{\circ}\text{C}/6^{\circ}$ . |

(4) Sound values are measured in a semi-anechoic room. Sound pressure level is a relative value, depending on the distance and acoustic environment. For more details, please refer to the sound level drawings. Sound power level is an absolute value that a so |

(5) For more details, see operation range drawing |

(6) 4 pole 20 A curve 400V tripping class C (refer to wiring diagram) |

(7) Above mentioned power supply of the hydrobox is for the backup heater only. The switch box and the pump of the hydrobox are supplied via the outdoor unit. The optional domestic hot water tank has a separate power supply. |

Select diameter and type according to national and local regulations

Technical specifications			ELBX12E9W	
Heater capacity	Step 1	kW	3	
	Step 2	kW	max. 6 kW	
Casing	Colour		White + Black	
	Material		Resin, sheet metal	
Dimensions	Unit	Height	mm	840
		Width	mm	440
		Depth	mm	390
	Packed unit	Height	mm	450
		Width	mm	650
		Depth	mm	1,016
Weight	Unit	kg	48.5	
	Packed unit	kg	60	
Packing	Material		Carton / EPS / PE (Straps) / Wood (pallet)	
	Weight	kg	12	
PED	Category		Category II	
	Most critical part	Name		Plate heat exchanger
		P <sub>s</sub> *V	Bar*l	60
Refrigerant side heat exchanger	Type		Plate heat exchanger	
	Quantity		1	
	Plates	Quantity	66	
Pump	Type		Grundfos UPM4L K 15-75 130 9 DK1	
	Nr of speeds		PWM	
	Power input	W	70	
Water side Heat exchanger	Type		Plate heat exchanger	
	Model		ACH43-66AH-F	
	Quantity		1	
	Plates	Quantity	66	
	Water volume	l	1.58	
	Water flow rate	Min. l/min	20.0 (1)	
Expansion vessel	Volume	l	10	
	Max. water pressure	bar	3	
	Pre pressure	bar	1	

# 2 Specifications

## 2 - 1 Specifications

Technical specifications				ELBX12E9W		
Water filter	Diameter perforations		mm	0.8		
	Material			Stainless steel / Plastic		
General	Supplier/ Name or trademark			Daikin Europe N.V.		
	Manufacturer Name and address details			Daikin Europe N.V. - Zandvoordestraat 300, 8400 Oostende, Belgium		
Water circuit	Piping connections diameter		inch	G 1" (female)		
	Piping material			Cu		
	Internal piping diameter		inch	1"		
	Piping		inch	1"		
	Safety valve		bar	3		
	Manometer			Digital		
	Drain valve / fill valve			Yes		
	Shut off valve			Yes		
	Air purge valve			Yes		
	Total water volume		l	3.6		
	Minimum water volume in the system for cooling		l	20 (2)		
Minimum water volume in the system for heating		l	20 (2)			
Refrigerant circuit	Gas side diameter		mm	15.9		
	Liquid side diameter		mm	6.35		
Sound power level	Nom.		dB(A)	44.0 (3)		
Sound pressure level	Nom.		dB(A)	30.0 (4)		
Operation range	Heating	Ambient	Min.	°C	-25 (5)	
			Max.	°C	25 (5)	
		Water side	Min.	°C	15 (5)	
			Max.	°C	65 (5)	
	Indoor installation	Ambient	Min.	°CDB	5	
			Max.	°CDB	35	
	Cooling	Ambient	Min.	°CDB	10 (5)	
			Max.	°CDB	43 (5)	
		Water side	Min.	°C	5 (5)	
			Max.	°C	22 (5)	
	Domestic hot water	Ambient	Min.	°CDB	-25 (5)	
			Max.	°CDB	35 (5)	
		Water side	Min.	°C	25 (5)	
			Max.	°C	62 (5)	
Safety devices	Item	01		Thermal cut out		
Electrical specifications				ELBX12E9W		
Power supply	Name			See note 7		
	Voltage range	Min.	%	-10		
Max.		%	10			
IP class	IP			IP X0B		
Electric heater	Power supply	Name		9W		
		Phase		3~		
		Frequency		Hz		50
		Voltage		V		400
	Current	Maximum running current		A		13.0
	Recommended fuses		A		20.000 (6)	

# 2 Specifications

## 2 - 1 Specifications

**2**

Electrical specifications			ELBX12E9W
Wiring connections	Communication cable	Quantity	3+GRD
		Remark	1.5 mm <sup>2</sup>
	Electric meter	Quantity	2
		Remark	Minimum 0.75 mm <sup>2</sup> (SVDC pulse detection)
	Preferential kWh rate	Quantity	Power: 2
		Remark	Power 6.3A (Select diameter and type according to national and local regulations)
	Domestic hot water pump	Quantity	2
		Remark	Minimum 0.75 mm <sup>2</sup> (2A inrush, 1A continuous)
	For power supply back-up heater	Quantity	Prewired
		Remark	Select diameter & type according to national & local regulations
	For connection with R6T	Quantity	2
		Remark	Minimum 0.75 mm <sup>2</sup>
	For connection with A3P	Quantity	Depends on thermostat type, cf. installation manual
		Remark	Voltage: 230V / Max. current: 100mA / Min. 0.75mm <sup>2</sup> / See note 8
	For connection with M2S	Quantity	2
		Remark	Voltage: 230V / Max. current: 100mA / Min. 0.75mm <sup>2</sup> / See note 8
For connection with optional FWXV* (demand input and output)	Quantity	4	
	Remark	100 mA, minimum 0.75 mm <sup>2</sup>	

(1) Operation area is extended to lower flow rates depending on operation mode - refer to ESP curve. |

(2) Excluding the water volume in the unit. This volume will guarantee sufficient defrost energy for all applications, however, this volume can be multiplied by 0,66 if the heating setpoint is  $\geq 45^{\circ}\text{C}$  (eg. Fan coils) |

(3) Measured with a pressure drop of 10 kPa in the heating system at an operating condition of leaving water  $47\text{-}55^{\circ}\text{C}$  in a room with an ambient of  $20^{\circ}\text{C}$ . DB/WB  $7^{\circ}\text{C}/6^{\circ}$ . |

(4) Sound values are measured in a semi-anechoic room. Sound pressure level is a relative value, depending on the distance and acoustic environment. For more details, please refer to the sound level drawings. Sound power level is an absolute value that is so |

(5) For more details, see operation range drawing |

(6) 4 pole 20 A curve 400V tripping class C (refer to wiring diagram) |

(7) Above mentioned power supply of the hydrobox is for the backup heater only. The switch box and the pump of the hydrobox are supplied via the outdoor unit. The optional domestic hot water tank has a separate power supply. |

Select diameter and type according to national and local regulations

# 3 Electrical data

## 3 - 1 Electrical Data

**ELBH-E6V**
**ELBH-E9W**
**ELBX-E6V**
**ELBX-E9W**
**ELSH-E**
**ELSHB-E**
**ELSX-E**
**ELXSB-E**
**ELVH-E6V**
**ELVH-E9W**
**ELVX-E6V**
**ELVX-E9W**
**ELVZ-E6V**
**ELVZ-E9W**
**\* Electrical meter specification**

- Pulse meter type/voltage-free contact for 5 V DC detection by PCB.

- Possible number of pulses

·0.1· pulse/kWh

·1· pulse/kWh

·10· pulse/kWh

·100· pulse/kWh

·1000· pulse/kWh

- Pulse duration

minimum On time: ·40ms·

Minirr

- Measurement type (depending on installation)

Single-phase AC meter

Three-phase AC meter

 Three-phase AC meter Balanced loads

 Three-phase AC meter Unbalanced loads
**\* Electrical meter installation guideline**

- It is the responsibility of the installer to cover the complete power consumption with electrical meters (combination of estimation and metering is not allowed).

- Required number of electrical meters

Outdoor unit type		ERRA(08/10/12)EA*								
Indoor unit type		ELS(H/X)(B)12P(30/50)EF			ELB(H/X)12EF*			ELV(H/X/Z)12S(18/23)EJ*		
Backup heater type		EKECBU*	EKECBU*	EKECBU*	6V		9W	6V		9W
Backup heater power		1~	1~	3~	1~	3~	3~	1~	3~	3~
Backup heater		1 / 2 / 3	2 / 4 / 6	3 / 6 / 9	2 / 4 / 6	6 kW	3 / 6 / 9	2 / 4 / 6	6 kW	3 / 6 / 9
<b>Normal kWh rate power supply</b>										
Electrical meter type	1~	1	1	-	1	-	-	1	-	-
	3~ balanced	-	-	-	-	-	-	-	-	-
	3~ unbalanced	-	-	1	-	1	1	-	1	1
<b>Preferential kWh rate power supply</b>										
Electrical meter type	1~	2	2	1	2	1	1	2	1	1
	3~ balanced	-	-	-	-	-	-	-	-	-
	3~ unbalanced	-	-	1	-	1	1	-	1	1

**4D142815**

# 3 Electrical data

## 3 - 1 Electrical Data

3

ELBH-E6V  
 ELBH-E9W  
 ELBX-E6V  
 ELBX-E9W  
 ELVH-E6V  
 ELVH-E9W  
 ELVX-E6V  
 ELVX-E9W  
 ELVZ-E6V  
 ELVZ-E9W

Electrical specifications of the backup heaters and booster heaters

Type	6V				9W							
	2 - 4	2 - 6	2-4 (in case of emergency: 2)	6	3 - 6	3 - 9	3 - 6 (in case of	2				
Capacity setting	[kW]											
Capacity stage -	2	2	2	2	1	2	2	2				
Capacity stage -1-	2	2	2	2	6	3	3	3				
Capacity stage -2-	4	6	4	6	-	6	9	6				
Minimum time delay between stages	Note -4-				Note -4-							
Power supply (1)	Phase	1~			3~			3~				
	Frequency	50			50			50				
	Voltage	230 +-10%			230 +-10%			400 +-10%				
Nominal running current	A	17,4	26,1	17,4	26,1	15	8,7	13	8,7	13		
Current	Zmax (backup heater) (2)	Complex			0,22			-				
	Minimum Ssc value	kVA			(3)			-				
Capacity setting	kW											
Capacity stage -	1											
Minimum time delay between stages	Note -5-											
Nominal running current	+EK*V3											
Booster heater	+EK*Z2											
Zmax	Booster heater	(2)	Complex			-			75			
Nominal running current	Backup heater +-	Booster heater	A	30,4 (17,4+13)	39,1 (26,1+13)	30,4 (17,4+13)	39,1 (26,1+13)	28 (15 + 13)	21,7 (8,7+13)	26 (13+13)	21,7 (8,7+13)	26 (13+13)
	Backup heater +-	Booster heater	A					22,5 (15 + 7,5)	16,2 (8,7+7,5)	20,5 (13+7,5)	16,2 (8,7+7,5)	20,5 (13+7,5)
Minimum Ssc value	Backup heater +-	Booster heater + EK*V3	kVA					(3)				
	Booster heater + EK*Z2	Booster heater	kVA					(3)				
Notes	(1)	The above-mentioned power supply of the hydrobox is for the backup heater only.										
	(2)	The optional domestic hot water tank has a separate power supply. In accordance with EN/IEC 61000-3-11, it may be necessary to consult the distribution network operator to ensure that the equipment is connected only to a supply with Zsys ≤ Zmax.										
	(3)	The equipment complies with EN/IEC 61000-3-12.										
	EN/IEC 61000-3-11	European/International Technical Standard setting the limits for voltage changes, voltage fluctuations and flicker in public low-voltage supply systems for equipment with rated current ≤ 75 A.										
EN/IEC 61000-3-12	European/International Technical Standard setting the limits for harmonic currents produced by equipment connected to public low-voltage systems with input current > 16 A and ≤ 75 A per phase.											
Zsys	System impedance											

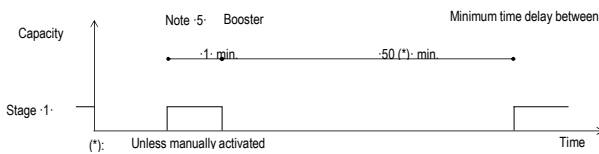
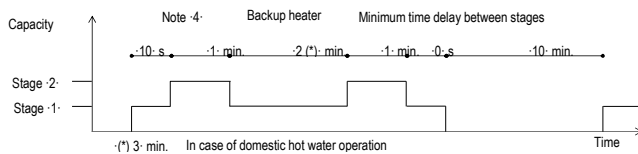

4D121020C

# 4 Combination table

## 4 - 1 Combination Table

ELBH-E6V

ELBH-E9W

ELBX-E6V

ELBX-E9W

**Factory-mounted equipment for -ELB(H/X)12EF\***

Description	ELB(H/X)12EF*	
	6V (8)	9W (8)
Heating only model -ELBH-	6V (8)	9W (8)
Reversible model -ELBX-	6V (8)	9W (8)
Backup heater -2.4-6kW 1N~230 V-	o	-
Backup heater -2.4-6kW 3~230 V-	o	-
Backup heater -3.6-9kW 3N~400 V-	-	o

**Kit availability for indoor units**

Reference	Description	ELB*12EF*	
		6V	9W
ELBH*	Heating only indoor unit		
ELBX*	Reversible indoor unit	6V	9W
EKRP1HBAA	Digital I/O PCB	*(1) (2)	o o
EKRP1AHTA	Demand PCB	*(3)	o o
BRC11HDA	Simplified user interface	*(4)	o o
EKPCACAB4	PC cable	*(4)	o o
EKHWS(P)150D3V3	Domestic hot water tank -150 l 1~230 V-		o o
EKHWS(P)180D3V3	Domestic hot water tank -180 l 1~230 V-		o o
EKHWS(P)200D3V3	Domestic hot water tank -200 l 1~230 V-		o o
EKHWS(P)250D3V3	Domestic hot water tank -250 l 1~230 V-		o o
EKHWS(P)300D3V3	Domestic hot water tank -300 l 1~230 V-		o o
EKHWP500BA	Domestic hot water tank with solar connection	*(9)(10)	o o
EKHWP500PBA	Domestic hot water tank with solar connection	*(9)(10)	o o
EKHWP300BA	Domestic hot water tank with solar connection	*(9)(10)	o o
EKHWP300PBA	Domestic hot water tank with solar connection	*(9)(10)	o o
EKHYPART	Third-party tank connection kit for thermostat pocket		o o
EKHYPART2	Third-party tank connection kit for thermostat contact		o o
EKMIKPOA	Bizone kit		o o
EKMIKPHA	Bizone kit		o o
EKMIKHMA	Hydraulics - mixed pump group	*(13)	o o
EKMIKHUA	Hydraulics - unmixed pump group	*(13)	o o
EKMIKBVA	Balancing vessel		o o
EKMIKDIA	Distributor for balancing vessel	*(14)	o o
KRCS01-1	Remote indoor sensor	*(5)	o o
EKRSCA1	Remote sensor for outdoor	*(5)	o o
EKCCS-W	Universal centralised user interface		o o
DCOM-LT/IO	DCOM gateway		o o
DCOM-LT/MB	DCOM gateway		o o
EKHBCONV	Conversion kit: heating only to reversible.		o o
BRP069A71	WLAN module	*(12)	o o
BRP069A62	LAN module	*(12)	o o
EKRELSG	Relay for Smart Grid		o o
ESAE04A01*	Daikin Residential Controller		o o

**Notes**

- PCB that provides additional output connections:
  - Control external heat source (bivalent operation).
  - Output remote ON/OFF signal space heating/cooling
  - Remote alarm output
- Additional relays to allow bivalent control in combination with an external room thermostat are field-supplied.
- PCB to receive up to -4- digital inputs for power limitation
- Data cable for connection with PC.
- Only 1 remote sensor can be connected: indoor OR outdoor sensor.
- The valve kit is mandatory if a heat pump convactor is installed on a reversible model (not mandatory for heating only models).
- EKRTETS- can only be used in combination with -\*KRTRB-
- The backup heater capacity depends on a user interface setting.
- Solar pump station
- Dedicated connection kit available: -EKEP\*-.
  - Multi-zoning wired controls
  - The WLAN cartridge is supplied in the accessory bag of the unit and is meant to be plugged into the SD card slot on the MMI-2. In case of bad signal reception, the WLAN cartridge can be removed and replaced by the WLAN or LAN module.
- Only possible in combination with -EKMIKPOA-
- Only possible in combination with -EKMIKBVA- and -EKMIKPHA- or -EKMIKHUA-

**Remark**

Other combinations than mentioned in this combination table are prohibited.

**Outdoor combination table for -ELB(H/X)12EF\***

Description	ERRA08EA(V3/W1)	ERRA10EA(V3/W1)	ERRA12EA(V3/W1)
ELBH12EF* Heating only	o	o	o
ELBX12EF* Reversible	o	o	o

**Kit availability for outdoor units**

Reference	Description	ERRA08EA(V3/W1)	ERRA10EA(V3/W1)	ERRA12EA(V3/W1)
EKMST1	Mounting stand	o	o	o
EKMST2	Mounting stand	o	o	o

Reference	Description	ELB*12EF*	
		6V	9W
ELBH*	Heating only indoor unit		
ELBX*	Reversible indoor unit	6V	9W
FWXV10-15-20ATV3	Heat pump convactor	*(6)	o o
FWXT10-15-20ATV3	Heat pump convactor	*(6)	o o
FWXM10-15-20ATV3	Heat pump convactor	*(6)	o o
EKVKHPC	Heat pump convactor valve kit	*(6)	o o
EKR7WA	Wired room thermostat		o o
EKRTRB	Wireless room thermostat		o o
EKRTE5	External sensor room thermostat	*(7)	o o
EKWUFHTA1V3	Multi-zoning base unit 230 V	*(11)	o o
EKWCTRD1V3	Digital thermostat 230 V	*(11)	o o
EKWCTRN1V3	Analogue thermostat 230 V	*(11)	o o
EKWCVATR1V3	Actuator 230 V	*(11)	o o

**Kit availability for domestic hot water tanks**

Reference	Description	*KHWP*			
		500BA	500PBA	300BA	300PBA
*KHWP*	Domestic hot water tank with solar connection	o	o	o	o
*KSRP5A4	Solar pump station				
EKEPRHLT3HX	Dedicated connection kit available.				
EKEPRHLT5H	Heating only indoor unit	o	o	o	o
EKEPRHLT5X	Only for reversible models	o	o		

4D143243A

# 5 Dimensional drawings

## 5 - 1 Dimensional Drawings

5

ELBH-E6V

ELBH-E9W

ELBX-E6V

ELBX-E9W

- ① Holes ·Ø8.5· for wall fixation
- ② Water out connection ·(1" F BSP)·
- ③ Water in connection ·(1" F BSP)·
- ④ Liquid pipe connection ·Ø 6.35· flare
- ⑤ Gas pipe connection ·Ø15.9· flare
- ⑥ Pump
- ⑦ User interface
- ⑧ Safety valve
- ⑨ Air purge
- ⑩ Expansion vessel
- ⑪ Magnetic filter / dirt separator
- ⑫ Plate heat exchanger
- ⑬ Shut-off valves
- ⑭ Wire entrance of the power supply / communication wire
- ⑮ Service door
- ⑯ Switch box terminals
- ⑰ Switch box terminals for the domestic hot water tank (option)
- ⑱ Backup heater
- ⑲ Chimney ··
- ⑳ Space heating water pressure sensor
- ㉑ Options

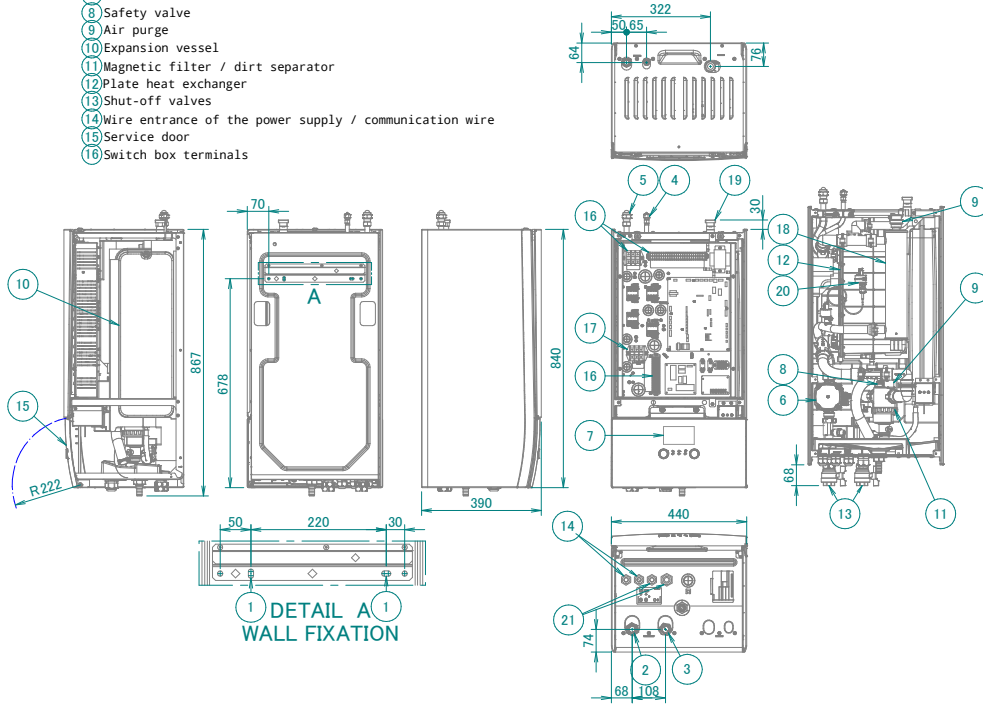

3D143233

# 6 Centre of gravity

6 - 1 Centre of Gravity

ELBH-E6V  
ELBH-E9W  
ELBX-E6V  
ELBX-E9W

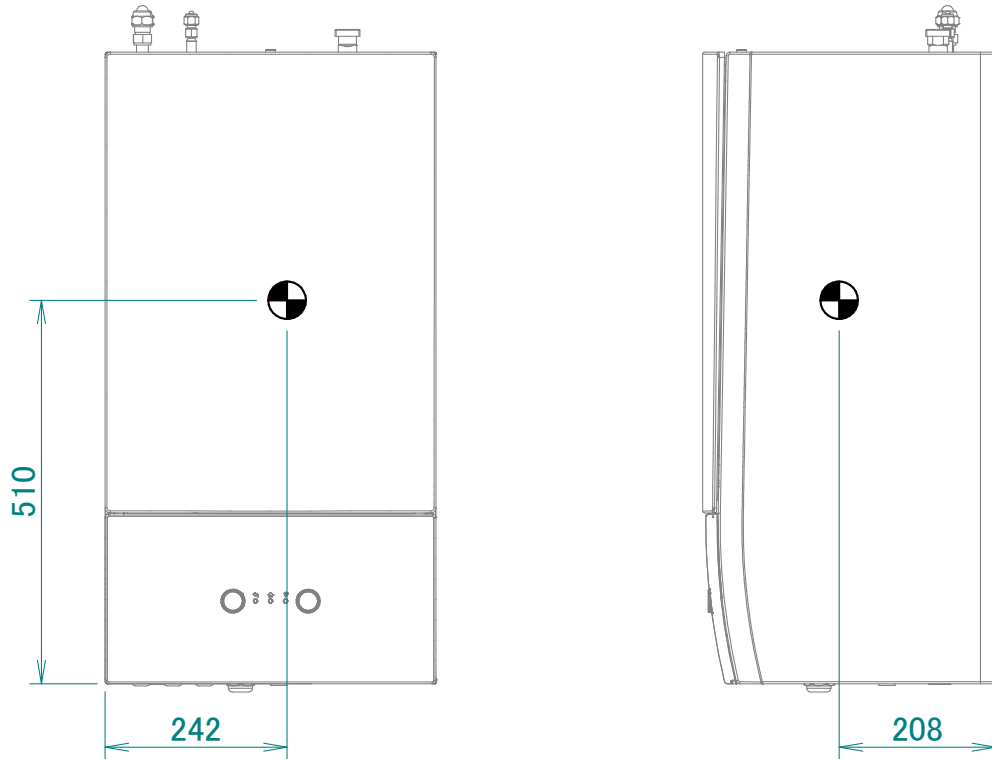

4D146974

# 7 Piping diagrams

## 7 - 1 Piping Diagrams

7

ELBH-E6V  
ELBH-E9W  
ELBX-E6V  
ELBX-E9W

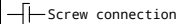
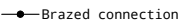
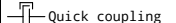
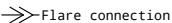

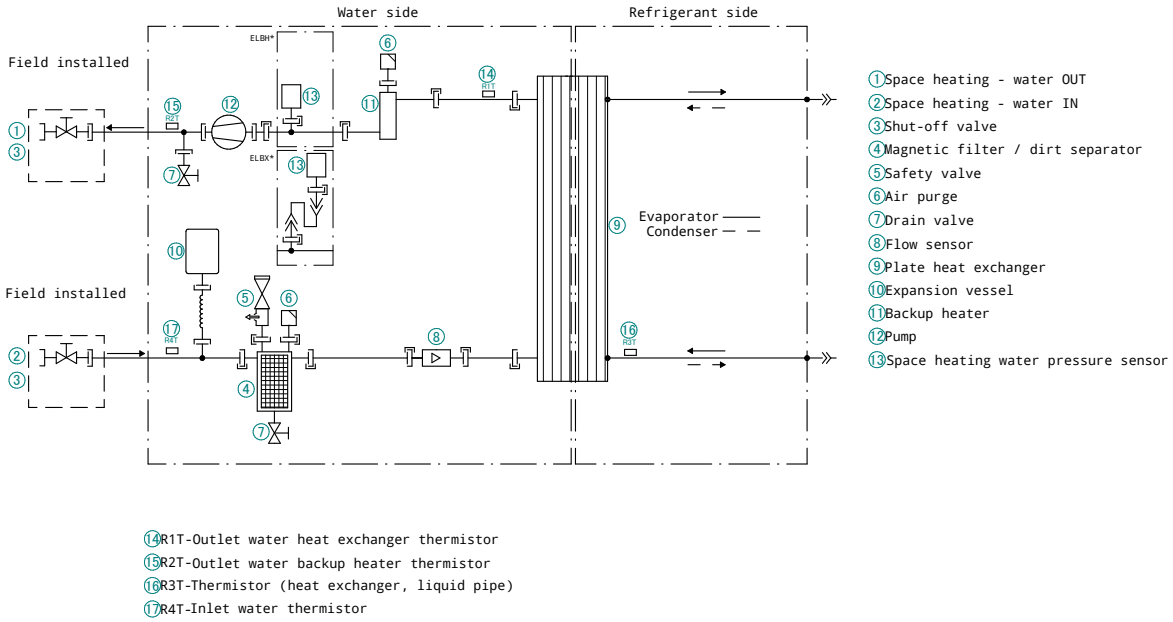
3D143231

# 8 Wiring diagrams

## 8 - 1 Notes & Legend

ELBH-E6V / ELBH-E9W / ELBX-E6V / ELBX-E9W

\* : optional # : field supply

### LEGEND

Translation can be found in the installation manual.



Part n°	Description	M3S
A1P	main PCB	
A2P	* On/OFF thermostat (PC=power circuit)	
A3P	* heat pump convactor	
A4P	* digital I/O PCB	
A8P	* demand PCB	
A9P	* status indicator	
A11P	* MMI main PCB	
A13P	* LAN adapter	
A14P	* user interface PCB	
A15P	* receiver PCB (wireless On/OFF thermostat)	
A20P	* WLAN module	
A30P	* Bizone mixing kit PCB	
B2L	flow sensor	
B1PW	water pressure sensor	
B5K (A3P)	solar pump station relay	
CN* (A4P)	* connector	
DS1 (A8P)	* dipswitch	
E1H	backup heater element (1 kW)	
E2H	backup heater element (2 kW)	
E4H	booster heater (3 kW)	
E*P (A9P)	indication LED	
F1B	# overcurrent fuse backup heater	
F2B	# overcurrent fuse booster heater	
F1T	thermal fuse backup heater	
F1U, F2U (A4P)	* fuse 5 A 250 V for digital I/O PCB	
FU1 (A1P)	fuse T 6.3 A 250 V for PCB	
K1A, K2A	* high voltage smartgrid relay	
K1M, K2M	contactor backup heater	
K3M	* contactor booster heater	
K5M	safety contactor BUH	
K*R (A1P-A4P)	relay on PCB	
M1P	main supply pump	
M2P	# domestic hot water pump	
M2S	# 2 way valve for cooling mode	
M3S	* 3 way valve for space heating /domestic hot water	
P1M	MMI display	
PC (A15P)	* power circuit	
PHC1 (A4P)	* optocoupler input circuit	
Q1L	thermal protector backup heater	
Q2L	* thermal protector booster heater	
Q4L	* safety thermostat	
Q*DI	# earth leakage circuit breaker	
R1H (A2P)	* humidity sensor	
R1T (A1P)	outlet water heat exchanger thermostat	
R1T (A2P)	* ambient sensor On/OFF thermostat	
R1T (A14P)	* ambient sensor user interface	
R2T (A1P)	outlet backup heater thermostat	
R2T (A2P)	* external sensor (floor or ambient)	
R3T	refrigerant liquid side thermostat	
R4T	inlet water thermostat	
R5T	* domestic hot water thermostat	
R6T	* external indoor or outdoor ambient thermostat	
S1S	# preferential kWh rate PS contact	
S2S	# electrical meter pulse input 1	
S3S	# electrical meter pulse input 2	
S4S	# smartgrid feed-in	
S6S-S9S	* digital power limitation inputs	
S10S-S11S	# low voltage smartgrid contact	
SS1 (A4P)	* selector switch	
SW1~2 (A12P)	turn buttons	
SW3~5 (A12P)	push button	
TR1	power supply transformer	
X6M	# BUH power supply terminal strip	
X6M	* BSH power supply connector	
X7M, X8M	* BSH power supply terminal strip	
X10M	* smartgrid power supply terminal strip connector	
X*, X*A, X**H*, X**Y		
X*M	terminal strip	

### NOTES TO GO THROUGH BEFORE STARTING THE UNIT

- X1M : Main terminal
- X2M : Field wiring terminal for AC
- X5M : Field wiring terminal for DC
- : Earth wiring
- - - : Field supply
- - - : Several wiring possibilities
- ① : Option
- : Not mounted in switch box
- : Wiring depending on model
- : PCB

Note 1 : Connection point of the power supply for the BUH/BSH should be foreseen outside the unit.

### POSITION IN SWITCH BOX

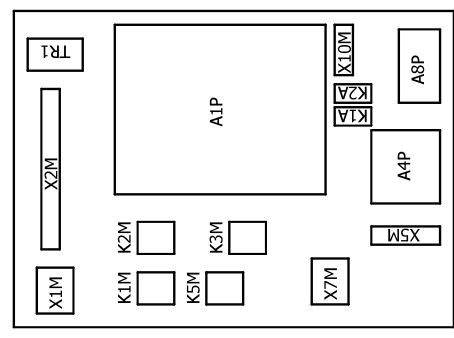

- Backup heater power supply
- 6T1 (3~, 230V, 6kW)
- 6V3 (1N~, 230V, 6kW)
- 6WN/9WN (3N~, 400V, 6/9kW)
- User installed options:
- LAN adapter
- Domestic hot water tank
- Remote user interface
- Ext. indoor thermostat
- Ext. outdoor thermostat
- Digital I/O PCB
- Demand PCB
- Safety thermostat
- Smartgrid kit
- WLAN adapter module
- WLAN cartridge
- Bizone mixing kit
- Main LWT:
- On/OFF thermostat (wired)
- On/OFF thermostat (wireless)
- Ext. thermostat
- Heat pump convactor
- Add LWT:
- On/OFF thermostat (wired)
- On/OFF thermostat (wireless)
- Ext. thermostat
- Heat pump convactor

4D143234A

# 8 Wiring diagrams

## 8 - 2 Control Circuit

ELBH-E6V / ELBH-E9W / ELBX-E6V / ELBX-E9W

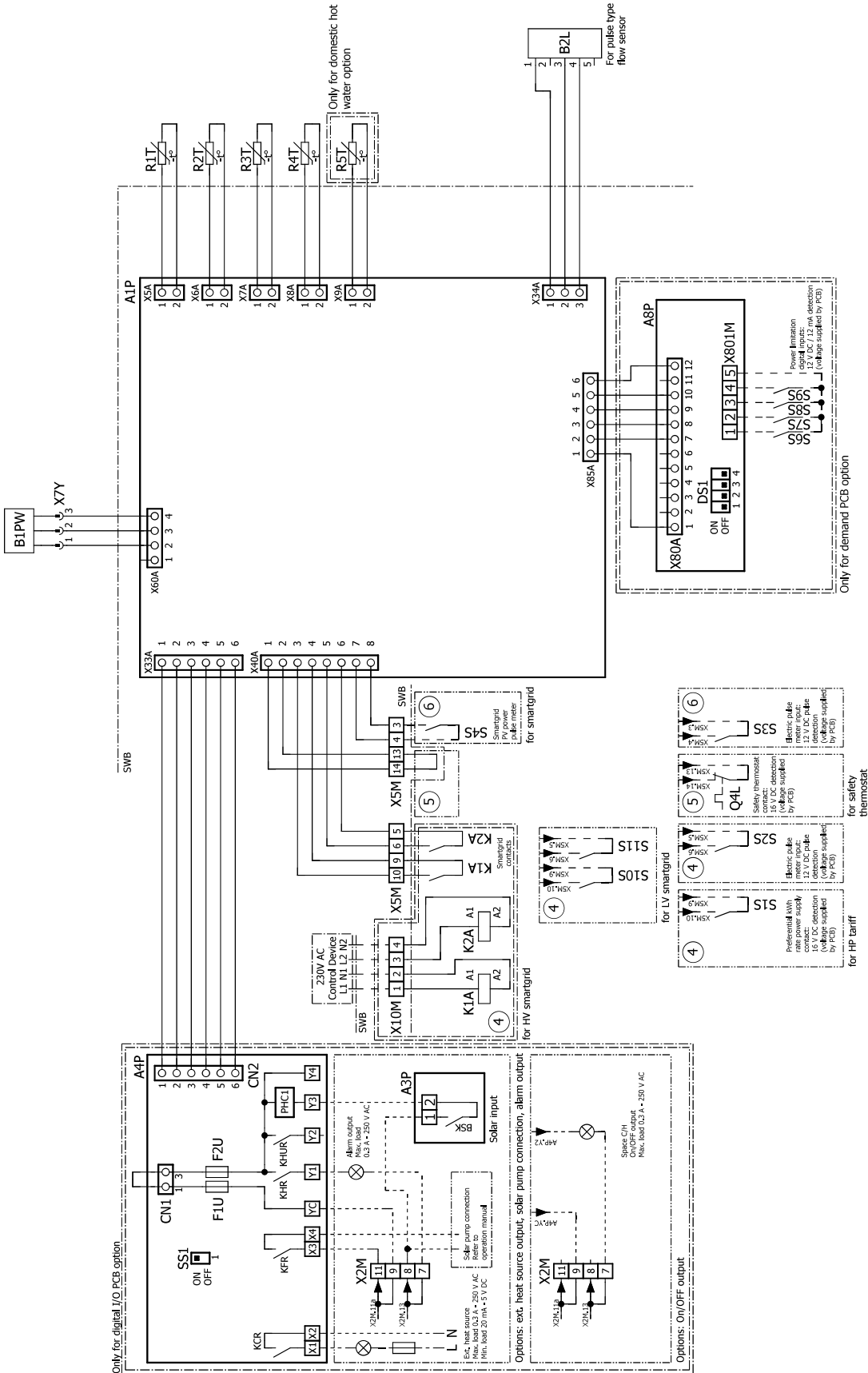

4D143234A





# 8 Wiring diagrams

## 8 - 3 Power Supply, Back-up Heater

ELBH-E6V / ELBH-E9W / ELBX-E6V / ELBX-E9W

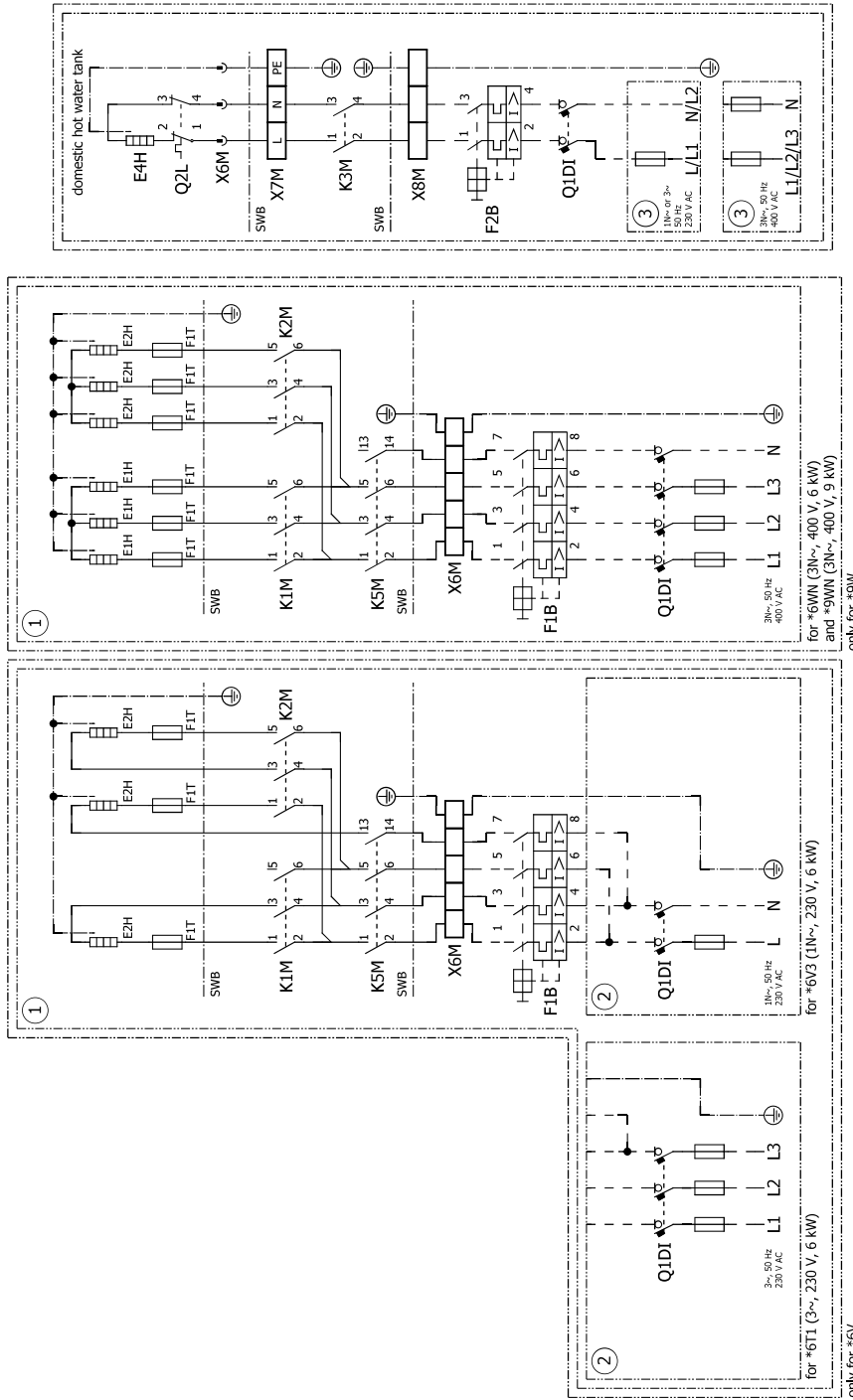

4D143234A

# 9 External connection diagrams

## 9 - 1 External Connection Diagrams

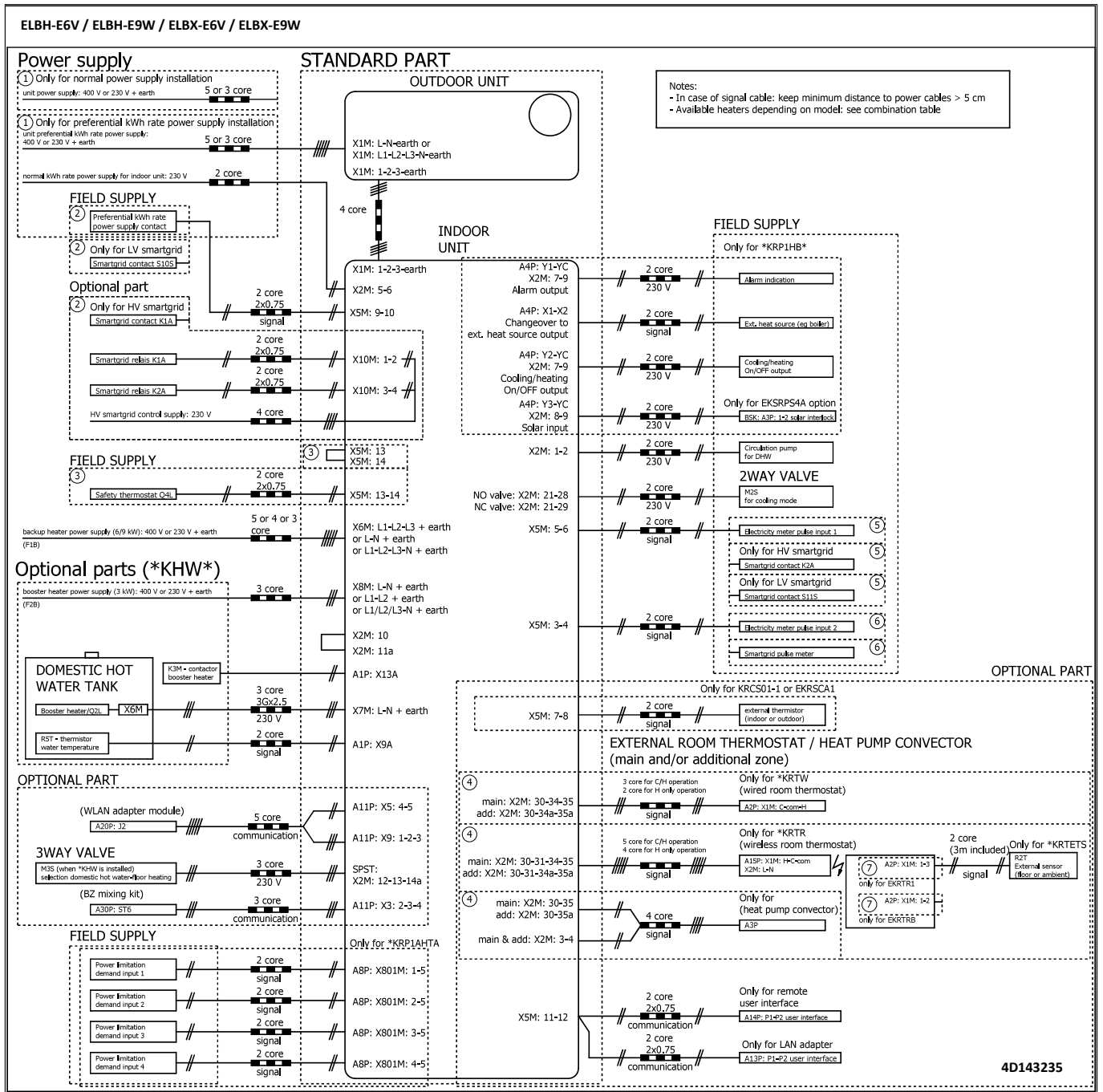

# 10 Installation

## 10 - 1 Installation Method

ELBH-E6V  
ELBH-E9W  
ELBX-E6V  
ELBX-E9W

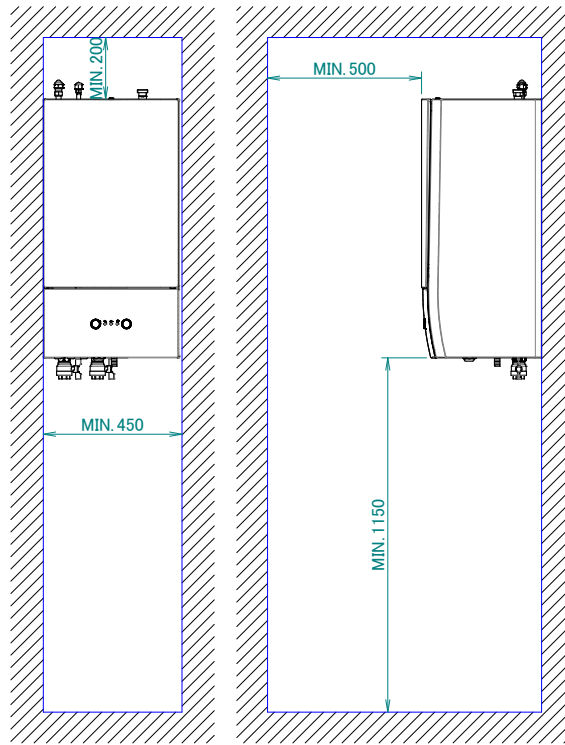

3D135872

# 11 Operation range

## 11 - 1 Operation Range

ELBH-E6V  
 ELBH-E9W  
 ELBX-E6V  
 ELBX-E9W  
 ELSH-E  
 ELSHB-E  
 ELSX-E  
 ELSXB-E  
 ELVH-E6V  
 ELVH-E9W  
 ELVX-E6V  
 ELVX-E9W  
 ELVZ-E6V  
 ELVZ-E9W

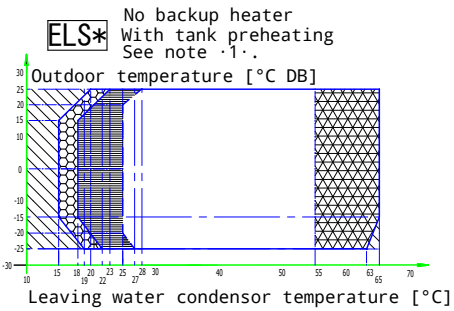
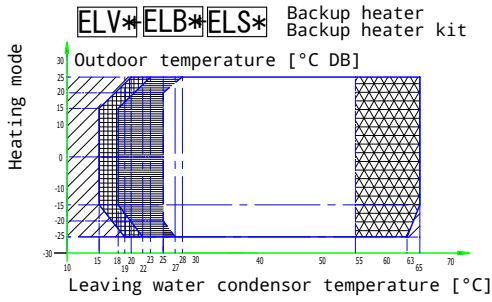
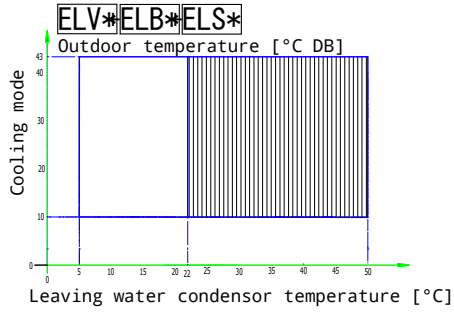

- Legend
- Backup heater only operation
  - No outdoor unit operation
  - Heat pump + backup heater operation
  - Pull-up area
  - Auxiliary boiler only operation
  - No outdoor unit operation
  - Heat pump + auxiliary boiler operation
  - Pull-up area
  - Outdoor unit operation if controller setpoint is regulated to minimal leaving water temperature request. See dashed lines

- Outdoor unit operation if setpoint > 55°C and ΔT = 10°C (ΔT = outlet temperature - inlet temperature)
- Pull-down area

Notes  
 1. Tank preheating  
 For details, see the installer reference guide.  
 2. In restricted power supply mode, the outdoor unit and backup heater can only operate separately.

3D142809

ELBH-E6V  
 ELBH-E9W  
 ELBX-E6V  
 ELBX-E9W  
 ELSH-E  
 ELSHB-E  
 ELSX-E  
 ELSXB-E  
 ELVH-E6V  
 ELVH-E9W  
 ELVX-E6V  
 ELVX-E9W  
 ELVZ-E6V  
 ELVZ-E9W

### Domestic hot water heating mode

$$ELV* + ELS* + EKHP* + \begin{matrix} EKHS*200* \\ EKHS*250* \\ EKHS*300* \end{matrix} + \begin{matrix} EKHS*150* \\ EKHS*180* \end{matrix}$$

Third-party with identical specifications as ·EKHS\*200\*·

Third-party with identical specifications as ·EKHS\*150\*·

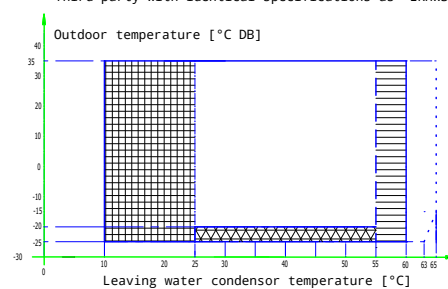
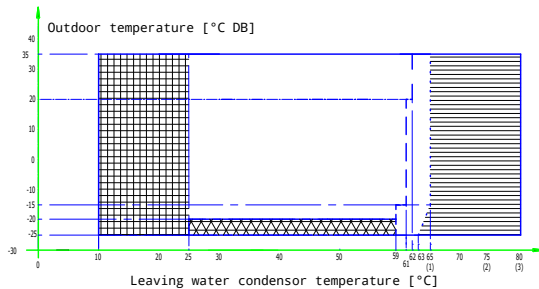

- Legend
- Setpoint [°C]
  - Domestic hot water
  - Leaving water temperature [°C]
  - Pull-up area
  - Booster heater only operation (if a booster heater is part of the system)
    - (1) ·ELV\*12\*· indoor units only
    - (2) Combination of ·EKHS\*· and ·ELB\*· indoor units / ·ELS\*12\*· indoor units only
    - (3) Combination of ·EKHP\*· and ·ELB\*· indoor units
  - Operation of the outdoor unit is possible. If the outdoor temperature drops below -20°C, unit will continue operation. But when the unit is OFF and the outdoor temperature is below -20°C, the outdoor unit will not start up. The indoor unit and backup heater will start in these cases.

Notes

1. In restricted power supply mode (·EKHP\*· only), the outdoor unit, booster heater and backup heater can only operate separately.
2. Third-party with identical specifications as ·EKHS\*150\*·  
 Coil surface > 1.05·m<sup>2</sup> and < 3.7·m<sup>2</sup>  
 Tank thermistor and booster heater above heat pump coil.
3. Third-party with identical specifications as ·EKHS\*200\*·  
 Coil surface > 1.8·m<sup>2</sup> and < 3.7·m<sup>2</sup>  
 Tank thermistor and booster heater above heat pump coil.

3D142810

# 12 Hydraulic performance

## 12 - 1 Static Pressure Drop Unit

ELBH-E6V  
 ELBH-E9W  
 ELBX-E6V  
 ELBX-E9W

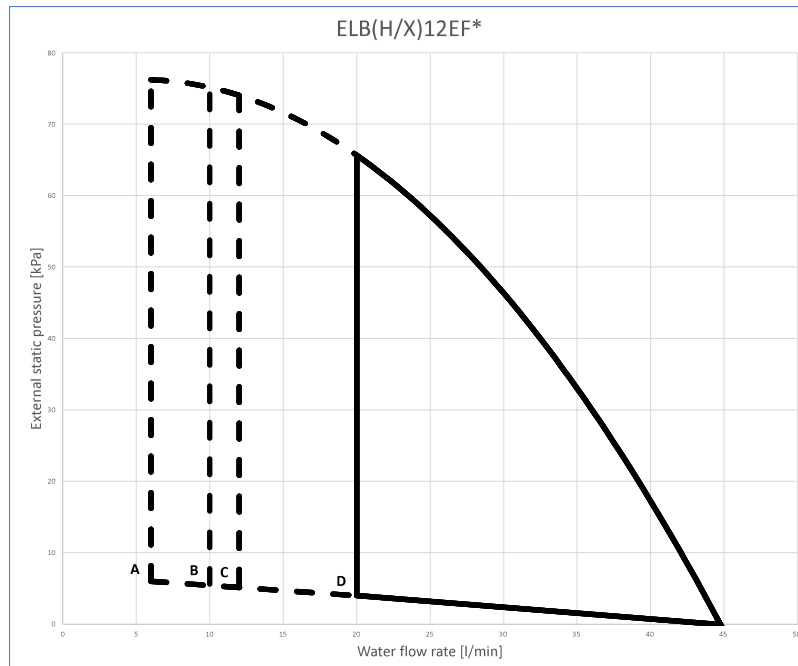

- A= Minimum water flow rate during normal operation
- B= Minimum water flow rate during cooling operation
- C= Minimum water flow rate during backup heater operation
- D= Minimum water flow rate during defrost operation

**Notes**

1. Selecting a flow outside the operating area can damage the unit or cause the unit to malfunction. See also the minimum and maximum allowed water flow range in the technical specifications.
2. Water quality must be according to EU directive 2020/2184.

3D146896

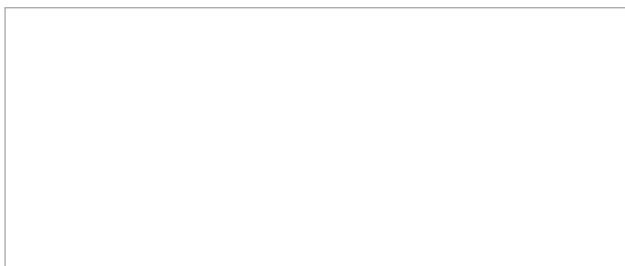

EEEDEN23

05/2023



The present publication is drawn up by way of information only and does not constitute an offer binding upon Daikin Europe N.V. / Daikin Central Europe HandelsGmbH. Daikin Europe N.V. / Daikin Central Europe HandelsGmbH have compiled the content of this publication to the best of their knowledge. No express or implied warranty is given for the completeness, accuracy, reliability or fitness for particular purpose of its content and the products and services presented therein. Specifications are subject to change without prior notice. Daikin Europe N.V. / Daikin Central Europe HandelsGmbH explicitly rejects any liability for any direct or indirect damage, in the broadest sense, arising from or related to the use and/or interpretation of this publication. All content is copyrighted by Daikin Europe N.V.